



# Design and Implementation of the Predictive Current Control Strategy in the Single Phase Photovoltaic Grid-Connected Inverter Based on Microcontroller

Hamed Javaheri Fard<sup>1</sup>, Hamid Reza Najafi<sup>2</sup>, Hossein Eliasi<sup>3</sup>

Faculty of Electrical & Computer Engineering, University of Birjand, Birjand, Iran.

<sup>1</sup>Hamed@Birjand.Ac.Ir, <sup>2</sup>H.R.Najafi@Birjand.Ac.Ir, <sup>3</sup>H\_Eliasi @Birjand.Ac.Ir

---

## Abstract

In this paper, photovoltaic (PV) grid-connected inverter which is the core device in PV grid-connected system has been in depth research. An improved predictive current controller has been developed by the Authors for single-phase grid-connected voltage source inverters (VSI). Based on DSP TMS320LF2407A, a 10 kW single-phase grid-connected inverter has been built in this paper. Thus is aimed at use in distributed generation. Because of the powerful real time processing ability of the DSP, the output power factor of the PV inverter connected with grid can be controlled to unity. The composition of main circuit and control loop is described in detail and the operating principle of each functional block is analyzed deeply. The experiment results show that the improved predictive controller has a superior performance. The single-phase grid-connected VSI implemented with the proposed predictive controller has shown very low current THD in laboratory test.

*Keywords:* Photovoltaic; Grid-connected inverter; Microcontroller 'TMS320LF2407A'; Predictive Current Control Strategy.

© 2015 IAUCTB-IJSEE Science. All rights reserved

---

## 1. Introduction

Renewable energy sources are one key enabler to decrease greenhouse gas emissions and to cope with the anthropogenic climate change [1]. The penetration of renewable distributed generation (DG) sources has been increased in active distribution networks due to their unique advantages [2]. Researchers have shown that renewable energy sources are able to fully meet the global energy requirements with almost no pollution and global warming emissions [3]. The solar energy and the wind energy are most widely used among the renewable energy sources. Photovoltaic (PV) systems have become a popular type of Distributed Generation Units (DGUs) for small and medium levels of renewable energy generation [4]. The power converters are required to operate more efficiently and effectively to maintain high power quality and dynamic stability. In general, power electronics is needed in almost all kinds of renewable energy system. It controls the renewable source and

interfaces with the load effectively, which can be grid-connection or working in stand-alone mode [5]. An inverter is essential for the interfacing of photovoltaic panels with the ac network. Normally, the grid system is considered as ac voltage source of infinite capacity, while the output of grid-connected inverter system can be controlled as voltage or current source. While, the output of the grid-connected inverter system is controlled as a  $V_{ac}$ , the PV grid-connected system and the grid are indeed two ac voltage sources in the parallel operation. To ensure stable operation of the grid-connected inverter system, the amplitudes and the phases of the output voltage of the inverter must be strictly controlled at the same time [6]. While, the PV grid-connected inverter system is designed as a current-source system, grid-connected system is actually a parallel connection of ac current source and voltage source.

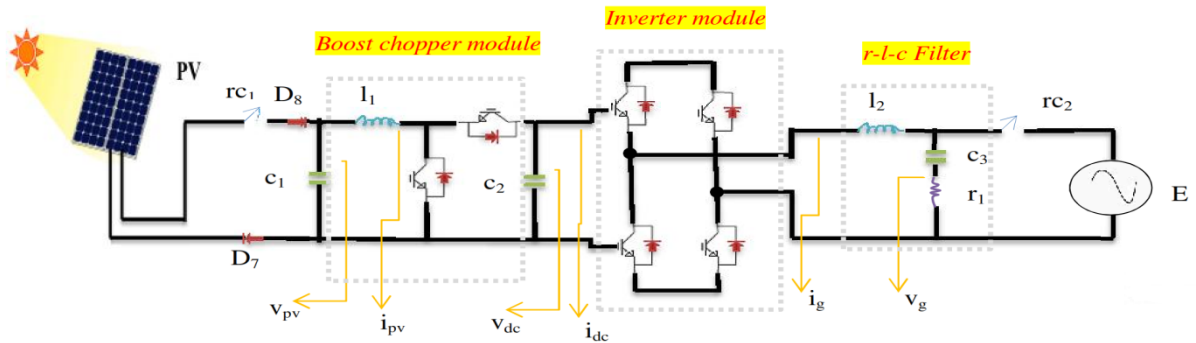

Fig. 1. The main circuit block diagram

With controlling the phase synchronization between grid-connected inverter system current and grid-system voltage, the output power factor can be guaranteed unit. The control case of voltage source input, and current source output is ratified in the design of PV grid-connected inverter. In this paper, a 10 KW single-phase grid-connected inverter based on TMS320LF2407A is described, which can convert dc power from solar panels to ac power connected with grid. Experimental results show that the inverter using the method proposed in this paper is high reliability, high efficiency, good stability and minimum distortion and harmonic noise.

### 1. The Structure And Principle Of Pv Grid-Connected Inverter

The entire structural diagram of grid-connected PV inverter is shows as Fig.1.

#### A) Principle of PV grid-connected inverter

The block diagram consists of three parts:

##### Boost chopper module:

A boost converter (step-up converter) is a dc-to-dc power converter with an output voltage greater than its input voltage. It is used to attain boost and Maximum Power Point Tracking (MPPT). Output voltage of the photovoltaic array is rose to 400V by using Boost-chopper, MPPT is to control the solar cell operating voltage by regulating the duty cycle of the boost on the basis of the V-I characteristics of solar cells so as to ensure that solar panels always operate at maximum power point.

##### Inverter module:

The full-bridge topology is adopted and the output current of the module is controlled in phase of grid voltage so that the system output power factor is guaranteed unit. dc-dc module and dc-ac module are connected via the dc link but independent in control.

##### "r-l-c" Filter:

ac-Side filter is composed of  $r_1$ ,  $l_2$ ,  $c_3$  used to filter ac side current harmonics to make certain the quality of grid current.

### 2. The Control Strategy For PV Grid-Connected Inverter

The control system software is designed in units, and each function is divided into the corresponding units. The main function units of control software comprise main program unit, MPPT unit, robust predictive current controller unit and anti-islanding unit. Therefore;

#### Main program unit:

The main program is to accomplish system initialization and the initialization of capture unit and a PWM (Pulse Width Modulation) -related registers.

#### MPPT unit:

Photovoltaic arrays must achieve maximum power point tracking control, to make PV arrays get the maximum power output continually at any insolation. The principle is that current array output power is obtained by detecting output voltage and current, and then the current array output power is compared with the previous one. Drop the smaller and keep the larger in order to find the maximum power point of the photovoltaic array. Actually, MPPT is typically a dynamic maxima-finding process. Golden Section Search technique  $\gamma = 1.6180339$  is used in the paper for finding a MPP. Experiment results show that this technique has the advantages of fast convergence, robustness and noise-resistance [7].

#### Predictive current controller unit:

About this unit and how to implement the predictive strategy on the single-phase inverter is given a detailed description in the section III.

### 3. Model Based Predictive Control Strategy

Model based predictive control (MBPC) being current in the recent decades has been played a significant role in the modern control engineering. This kind of control involves the widespread spectrum of applications such as chmical industry and even food industry as well. The term, predictive control, does not denote a specific control method; it refers to the wide range of the control methods in which obtaining

control signal by using minimization of a Cost function is possible through an explicit processing model. These design methods lead to the linear controllers which have the similar structure and the same degree of freedom. The basic idea emerged in the predictive control family is based on the following cases [8]:

- Using a model for predicting the output of the process in the future times.
- Calculating a sequence control with the aid of minimizing of a Cost function.
- Using the abandoning strategy which includes the utilization of the first control element in the calculated sequence control at any moment.

Different algorithms of MBPC among themselves are only different in the model used to display the process, noise, and the Cost Function which has to be minimized. This control method is widely used in the industry and in the academic sciences. Among the applications of this type of control are the uses of them in robot arm, steam generators, and so on. The good performance of these applications represents the potential of MBPC for obtaining the very most effective control systems that can be used with any intervention over a long period of time.

In the following, some advantages of MBPC are presented [8]:

- This method is implementable easily having a some knowledge about control since the concepts are easy to be understood with relatively simple properties.
- This control method can be used for controlling an endless series of processes whether with simple dynamics or with complex dynamics including the systems with huge time delays, the phase non-minimum systems, or the unstable systems.
- The multi-variable systems can be easily controlled by means of this method.
- This method is suitable for the dead-time systems.

This method has its own disadvantages. First, deriving it (obtaining control signal) is more complex than that of the classic Proportional-Integral-Derivative (PID) controllers. If the dynamic of the process does not change, the controller coefficients can be predetermined, but all calculations must be repeated for each time sample in the case of adaptive control. While the constraints are taken into account, the extent of necessary calculations rises. Second, there is an essential need for a proper model. However, the merits have superiority over demerits making it very useful in the industry.

#### A) Design and implementation of predictive current controller

A simplified connection model for a single-phase grid-connected inverter is shown in Fig.2, where the load current ( $I_L$ ) of the inverter is decided by the following differential equation:

$$v_{op} = v_g + L \frac{dI_L}{dt} \quad (1)$$

Where,  $v_g$  is the grid voltage, and  $v_{op}$  is the inverter output voltage.

Assuming the inverter operates with a constant switching frequency chosen by the inverter designer, the switching period is then a constant value. In the switching period  $[k, k+1]$ , Equation (1) can be written in a discrete form, as Equation (2),

$$v_{op-av}[k] = v_{g-av}[k] + \frac{I_L[k+1] - I_L[k]}{T_s} \cdot L \quad (2)$$

Where,  $T_s$  is the switching period,  $v_{op-av}[k]$  and  $v_{g-av}[k]$  are the average inverter output voltage and average grid voltage over the switching period  $[k, k+1]$ ,  $I_L[k+1]$  and  $I_L[k]$  are the measured load currents at the sampling points  $[k+1]$  and  $[k]$ .

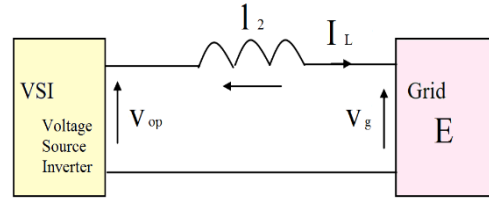

Fig. 2. The connection model of the inverter with a grid

As introduced in [9], the traditional predictive algorithm carries out computations during the previous switching period  $[k-1, k]$ . This means that only the measured values of current  $I_L[k-1]$  and grid voltage  $v_g[k-1]$  are available at time  $[k-1]$  when the calculations start. The controller needs to predict the  $I_L[k]$  and  $v_g[k]$  and calculate the demand inverter output voltage  $v_{op-av}[k]$ . Thus, the traditional predictive control algorithm can be described by Equation (3).

$$v_{op-av}[k] = 4v_g[k-1] - 2v_g[k-2] - v_{op-av}[k-1] + \frac{I_{ref}[k+1] - I_L[k-1]}{T_s} \cdot L \quad (3)$$

Our laboratory tests have shown the inverter controlled by this traditional predictive current algorithm has a poor performance under component parameter variations. The error between the actual and modeled filter inductance may cause oscillations of the inverter current. Here “modeled inductance” refers to the value known to the designer of a particular inductor, which may be different from the actual inductance. The traditional predictive algorithm conducts computations one switching period before the controlling point (i.e. when the control pulses to

the inverter power switches are sent out). The controller must use the results of previous switching cycles to forward estimate both the future grid voltage and future load current. These are the causes of the controller's poor performance under component parameter variations. For modern high speed DSP (Digital Signal Processor) processors, the control delays are at the microseconds range (for example, for the DSP processor TMS320LF2407A from Texas Instruments, the delay is about  $10 \mu s$  for a typical single-phase inverter). Compared to a period of  $16.6 ms$  for  $60 Hz$  grid voltages and currents,  $10 \mu s$  is so short that one can assume the sampled grid voltage and load current are unchanged during this short duration. Thus, there is no need to predict grid voltage  $v_{g-av} [k]$  and load current  $I_L [k]$ .

To overcome the drawbacks of the traditional predictive current controller, an improved robust predictive current controller is proposed in this paper.

The control principle of the improved predictive control methodology is illustrated in Fig.3.

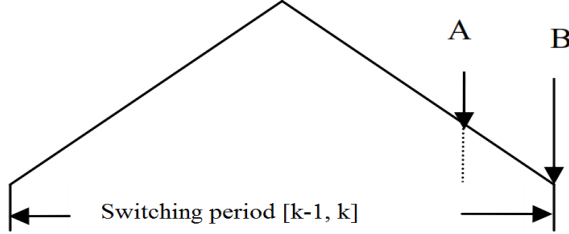

Fig. 3. Timing schematic of improved predictive controller

The sampling point (Point A) is set just ahead of controlling point (Point B) by a period of the control delays. The delay between the sampling point and controlling point is so short that one can assume the sampled grid voltage and inverter current at sampling point  $[k]$  (Point A) are equal to the values at controlling point  $[k]$  (Point B). Thus, the measured values of current  $I_L [k]$ , and grid voltage  $v_g [k]$ , are available for the controller to predict the demanded output voltage of the inverter. The improved predictive control algorithm is described by Equation (4).

$$v_{op-av} [k] = \underbrace{\frac{3}{2} v_g [k] - \frac{1}{2} v_g [k-1]}_{v_{g-av} [k]} + \frac{I_{ref} [k+1] - I_L [k]}{T_s} \cdot 1 \quad (4)$$

The term of within brackets in the equation (5) describes the robust predictive current control algorithm. It is simpler and consumes shorter DSP computation time. The experimental results show that the control algorithm has good performance under component parameter variations [10].

#### B) The remaining explanations of section II

##### Anti-islanding unit:

When the system operates in direct grid-connected style, in addition to the basic protection functions

such as short circuit, over voltage, over current, etc., it also should have the special feature of anti-islanding effect. The so-called "islanding effect" means under certain local load conditions, the distributed generation system can maintain a stable output power with a steady voltage and frequency even though the grid is disconnected from the point of common coupling [11]. Islanding effect has a considerable danger and even may be life-threatening. As a result, it is essential for the PV grid-connected systems to have the function of anti-islanding effect. The key of anti-islanding effect is the grid power detection, and the shorter the detection time is, the better [12]. In this paper, the method of disturb grid output current to detect grid breakdown occurs the principle of the proposed method is that the balance between supply and demand is damaged actively by the controlling microprocessor, and imposing cyclical movements to the output current of the inverter.

#### 4. General Design of Control Circuit

The general design of control circuit is shown as Fig.4. As previously noted, the microcontroller used is a TMS320LF2407A (microchip), which is produced by TI company. Control loop block diagram is composed of four parts:

##### Interfacing board:

It is used to sample the signals from the inverter main circuit by components such as PV voltage  $v_{pv}$ , current  $i_{pv}$ , dc bus voltage  $v_{dc}$ , current  $i_{dc}$ , and grid voltage  $v_g$ , grid current  $i_g$ , and heat-sinking temperature 't' and other analog data. The sampled data are transformed into 0~3.3V voltage signals for the input of the DSP. The CPLD (Complex Programmable Logic Device) integrates the fault signals of over-current of dc link and inverter output, over-voltage of the grid, dc link and generator, under-voltage of the grid and generator, over-frequency of the grid voltage, under-frequency of the grid voltage, over-temperature of IGBT (Insulated-Gate Bipolar Transistor), and so on, power modules into the DSP-protection interrupt input PDPINTA (Power Drive Protection Interrupt A) and PDPINTB and blockage PWM signals.

##### DSP board:

TMS320LF2407A is the core of DSP control board used to complete the functions of MPPT, software lock-in, A/D conversion, fault protection, and grid-connected inverter control, etc. In addition, through the RS232 communication port, the communication between display panel and remote control computers can be realized by control circuit.

##### Driver Board:

It is responsible for transmitting the driver signal and receiver fault signal of short circuit, over-current of power device, etc.

##### Display panel:



It is responsible for communication with grid-connected inverter, displaying and recording the parameters of system.

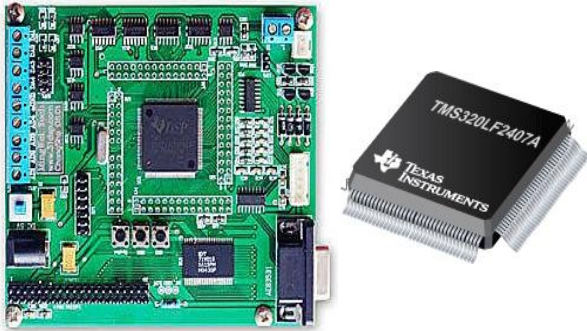

Fig. 4. The general design block diagram of control board

## 5. Results of Experiment

Table.1 shows design specification of the system available in fig.1.

Table.1.  
Device parameters

$P_{in}$	10 kw
$c_1$	12 $\mu$ f
$c_2$	12 $\mu$ f
$V_{c1}, V_{c2}$	1 kv
$l_1$	0.15 mH
IGBT inverter	IRG4PC50UD
dc link	f & 400 v $\mu$ 800
$l_2$	0.5 mH

Note the following figures. Analysis is carried out on the grid voltage and grid current.

As can be seen from Fig.5, the grid voltage remains sine. This voltage is the same until the end of the simulation period. From the figure can be seen that the grid voltage during simulation is completely stable.

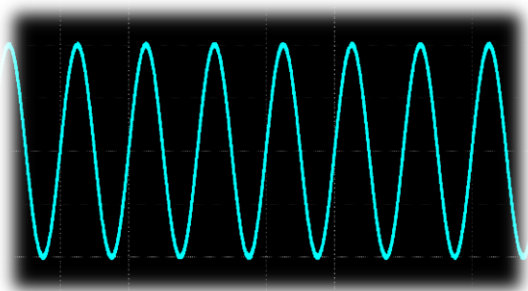

Fig. 5. The grid voltage, 200V/div

Like Fig.5, the grid current be entirely sinusoidal. The grid current is also shown in Fig.6. It is obvious that this current is exactly in phase with the grid voltage. It should be noted that the current is stable and robust.

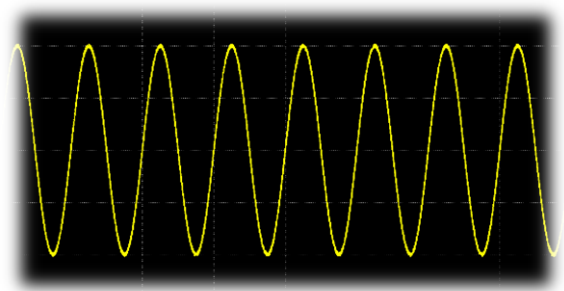

Fig. 6. The grid current, 100A/div

In Fig.7, the frequency spectrum test has been done on the grid. The experiment shows the current THD. The Total Harmonic Distortion, or THD, of a signal is a measurement of the harmonic distortion present and is defined as the ratio of the sum of the powers of all harmonic components to the power of the fundamental frequency. THD is used to characterize the linearity of audio systems and the power quality of electric power systems. Distortion factor is a closely related term, sometimes used as a synonym. In power systems, lower THD means reduction in peak currents, heating, emissions, and core loss in motors.

Inverter output current with the improved current predictive controller is depicted in Fig.8. It is also sinusoidal in laboratory test. Ripple of current is very low and in fact negligible. Excellent dynamic performance, it seems. In this figure can be seen that there is no overshoot.

As in all current and voltage waveforms can be seen above, the waveforms have super-fast dynamic response; the answer is fully stable and robust. In all of these benefits is due to the precise design the controller. It also is clear that there are no overshoot.

Switching voltage of inverter is shown in Fig.9. If the sampling time is reduced, Ripple of voltage will be low. It should be noted that Ripple of this wave is very low. It is worth noting that the sampling time can be reduced to some extent, because the sampling time is directly related to harmonics. Therefore sampling time can be set up on the 10 micro-seconds.

At the end of the experimental simulation results, dc link voltage also is depicted in Fig.10. From this figure it is seen that the capacitive link voltage at all simulation times ideally is stable and robust actually. This voltage is adjusted on 400 volt exactly.

## 6. Conclusion

Predictive current controllers are an effective method to improve the power quality of grid-connected inverter-based distributed generation systems. In this paper, the control technology of PV grid-connected inverter is researched, and the based on DSP TMS320LF2407A, a 10kW single-phase grid-connected photovoltaic inverter has been developed. The traditional predictive current

controller has a poor performance under component parameter variations. The improved predictive current controller as proposed by the Authors can effectively enhance the robustness of the PWM controller by improving the transient response characteristics of inverter systems, as demonstrated by theoretical analyses, computer simulations and laboratory tests. Because of the powerful real time processing ability of the DSP, the inverter output current can accurately follow the grid voltage. The experimental results are provided to validate the effectiveness of the proposed control strategy, showing that it is very suitable for distributed renewable power generation. The simulation results show the robustness and effectiveness of this control method. Future research will may be conducted based on the implementation of predictive control strategy to other renewable sources. For more information refer to [13-19].

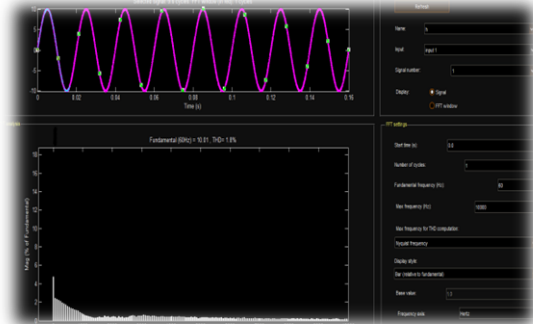

Fig. 7. A Fast Fourier Transform (FFT) for grid current with THD=1.8%

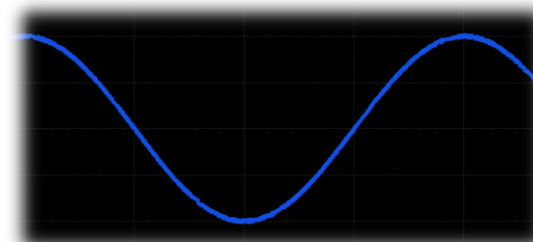

Fig. 8. Inverter output current with the improved current predictive controller

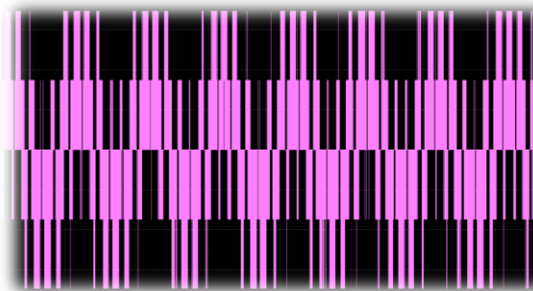

Fig. 9. The Switching voltage of inverter

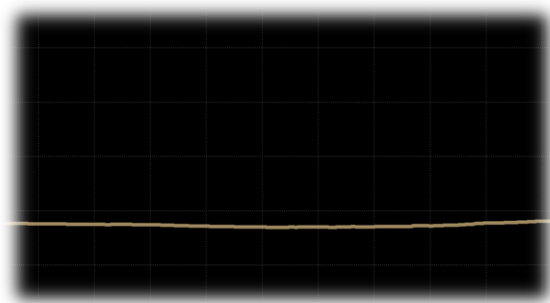

Fig. 10. The dc link voltage

## References

- [1] Strasser.T, Andren.F, Kathan.J, Cecati.C, Buccella.C, Siano.P, Leitao.P, Zhabelova.G, Vyatkin.V, Vrba.P, Marik.V, "A Review of Architectures and Concepts for Intelligence in Future Electric Energy Systems," *Industrial Electronics, IEEE Transactions on*, Volume: 62, Issue: 4, pp. 2424 - 2438, 2015.
- [2] Sedghi.M, Ahmadian.A, Aliakbar-Golkar.M, "Optimal Storage Planning in Active Distribution Network Considering Uncertainty of Wind Power Distributed Generation," *Power Systems, IEEE Transactions on*, Volume: PP, Issue: 99, pp. 1 - 13,2015.
- [3] Masood.B, Naqvi.R.A.H, Asif.R.M, "Designing of a control scheme for the solar rickshaw in comparative study with conventional auto rickshaw," *Engineering Technology and Technopreneuship (ICE2T), 4th International Conference on, IEEE Conference Publications*, pp. 324 - 329, 2014.
- [4] Saleh.S, Aljankawey.A, Sayid.B, Abu-Khaizaran.M, "Influence of Power Electronic Converters on Current-Voltage Behaviors During Faults in DGU's - Part II: Photovoltaic Systems," *Industry Applications, IEEE Transactions on*, Volume: PP, Issue: 99, pp. 1, 2015.
- [5] Choi.U.M, Lee.K.B, Blaabjerg.F, "Power electronics for renewable energy systems: Wind turbine and photovoltaic systems," *Renewable Energy Research and Applications (ICRERA), International Conference on, IEEE Conference Publications*, pp. 1 - 8, 2012.
- [6] Wei Zhao "Research on Grid-Connected Photovoltaic System" [D]. Hefei: Hefei University of Technology 2003.
- [7] Riming Shao, Liuchen Chang "A New maximum power point tracking method for photovoltaic arrays using golden section search algorithm", *Electrical and Computer Engineering, CCECE 2008, Canadian Conference on*, pp. 619 - 622, 2008.
- [8] E.F.Camacho and C.Bordons, "Model Predictive Control," *Book, Springer*, 2004.
- [9] D.G. Holmes and D.A Martin, "Implementation Of A Direct Digital Predictive Current Controller for Single and Three Phase Voltage Source Inverter," *In Conf. Rec.1996 Annual Meeting IEEE Industry Applications*, pp. 906 - 913,1996.
- [10] Hossein Madadi Kojabadi, Bin Yu, Idris A. Gadoura, Liuchen Chang, Mohsen Ghribi "A Novel DSP-Based Current-Controlled PWM Strategy for Single Phase Grid Connected Inverter" *IEEE TRANSACTIONS ON POWER ELECTRONICS, VOL. 21, NO. 4*, pp. 985 - 993, 2006.
- [11] Shicheng Zheng, Ming Ding, Jianhui Su, Meiqin Mao, Guorong Zhang, "Simulation and Experiment Research of Photovoltaic Generation System and Its Islanding", *JOURNAL OF SYSTEM SIMULATION*, Vol. 17, No.12, Dec. 2005.
- [12] Libo Wu "Research and Implementation of Control Strategy in Grid-connected Photovoltaic Systems" [D].Beijing: Tsinghua University 2006.
- [13] H. Eliasi, M.B. Menhaj, H. Davilu, "Robust nonlinear model

- predictive control for a PWR nuclear power plant,” *Progress in Nuclear Energy*, Elsevier, Volume: 54, Issue: 1, pp. 177 - 185, 2012.
- [14] H. Eliasi, M.B. Menhaj, H. Davilu, “Robust nonlinear model predictive control for nuclear power plants in load following operations with bounded xenon oscillations,” *Nuclear Engineering and Design*, Elsevier, Volume: 241, Issue: 2, pp. 533 - 543, 2011.
- [15] H. Eliasi, H. Davilu, M.B. Menhaj, “Adaptive fuzzy model based predictive control of nuclear steam generators,” *Nuclear Engineering and Design*, Elsevier, Volume: 237, Issue: 6, pp. 668 - 676, 2007.
- [16] H. Javaheri Fard, H.R. Najafi, “Predictive algorithm in a wind turbine with doubly fed induction generator (DFIG) to Power Control Using the the rotor current,” 29 th International Power System Conference, Energy Research, 27 - 29 October 2014.
- [17] H. Javaheri Fard, H.R. Najafi, H. Eliasi, “Direct predictive control strategy of active and reactive powers, applied to the converter AC / DC / AC, in a double-fed induction generator based wind turbine,” 12 th Technologies of Power Electronic Seminar, Sharif seminar on power electronics, Sharif University of Technology, March 3rd and 4th 2015.
- [18] H. Javaheri Fard, H. Eliasi, H.R. Najafi, “Direct predictive control strategy of active and reactive powers, applied to the converter AC / DC / AC, in a double-fed induction generator based wind turbine,” 7 th Electric Power Generation Conference & Exhibition (EPGC), 17 - 18 Feb 2015.
- [19] H. Javaheri Fard, H.R. Najafi, J. Najafi, “Offering a variety of configurations and model based predictive controller on photovoltaic inverter systems,” 4 th Annual Clean Energy Conference (ACEC 2014), Kerman University, 25 - 26 June 2014.